

①

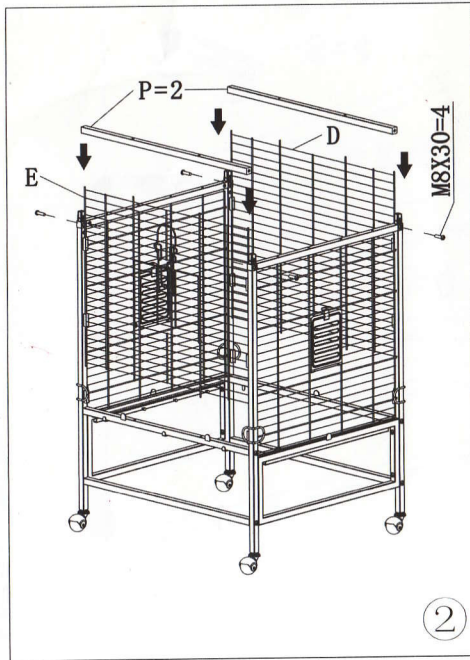

②

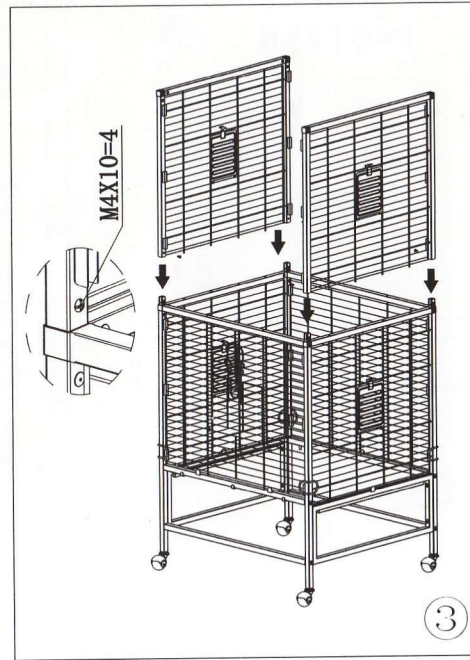

③

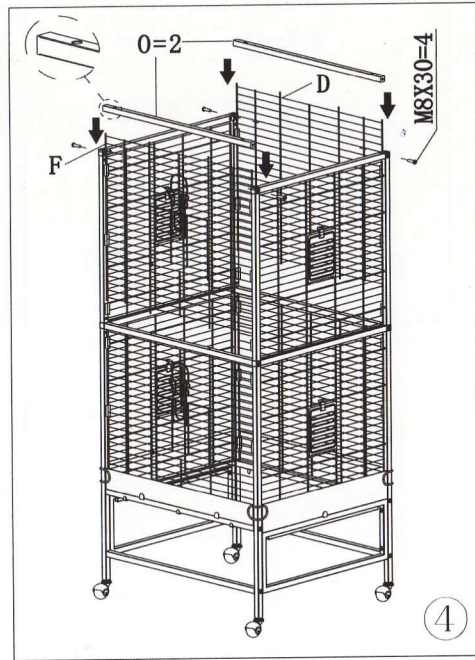

④

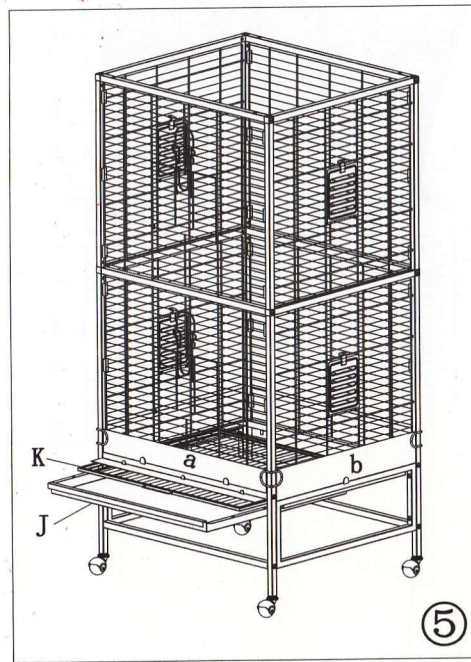

⑤

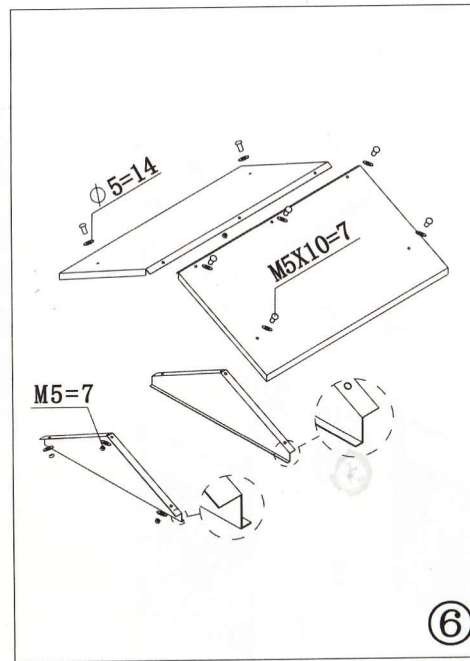

⑥

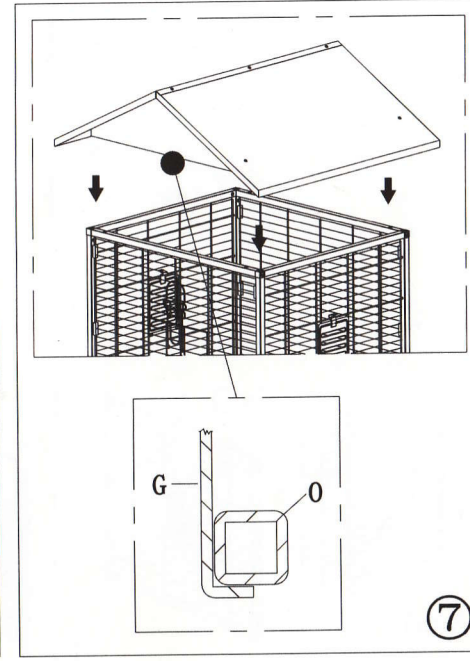

⑦

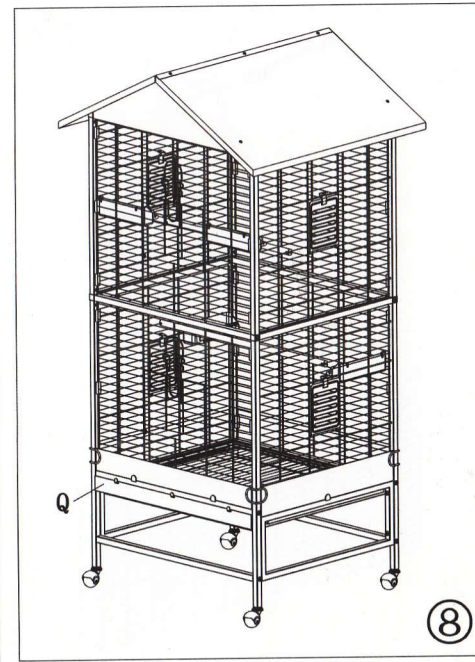

⑧

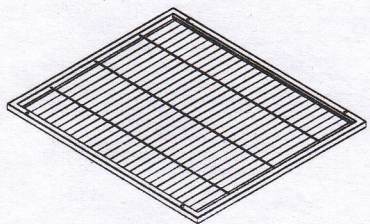

M8X30=4

If you want this cage with flat roof, follow the below steps after step#5.

